



 Canalina modulare in alluminio per aspirazione di gas e fumi inquinanti tramite elementi scorrevoli porta-tubo o porta-braccio articolato. Caratterizzata da estrema flessibilità di utilizzo, leggerezza e ampia gamma disponibile, la serie CZ è disponibile in varie dimensioni per sopprimere a diversi volumi di aspirazione richiesti.

 Modular aluminium track for extracting pollutant gases and fumes via sliding hose support elements or articulated arm supports. The CZ series is extremely flexible, lightweight and available in a wide range of models and sizes so that it is suitable for various extraction volume requirements.

 Rail modulaire en aluminium pour aspiration de gaz et fumées polluantes par l'intermédiaire d'éléments coulissants porte-tuyau ou porte-bras articulé. Caractérisé par une extrême souplesse d'utilisation, sa légèreté et sa gamme très large, la série CZ existe en plusieurs dimensions pour satisfaire les différents volumes d'aspiration nécessaires.

 Modularer Saugschlitzkanal aus Aluminium für die Abgas- und Rauchabsaugung über mit Laufwagen montierte Schläuche und Gelenkarme. Die Serie CZ zeichnet sich durch außergewöhnliche Flexibilität, Leichtigkeit und ein umfassendes Angebot aus. Sie ist in diversen Abmessungen erhältlich, um den verschiedenen Anforderungen in Hinblick auf das Absaugvolumen nachzukommen.

 Carril modular de aluminio para aspirar gases y humos contaminantes mediante elementos deslizantes porta-tubo o porta-brazo articulado. Caracterizada por la gran flexibilidad de uso, el poco peso y la amplia gama disponible, la serie CZ propone varias dimensiones para dar respuesta a los distintos volúmenes de aspiración requeridos.

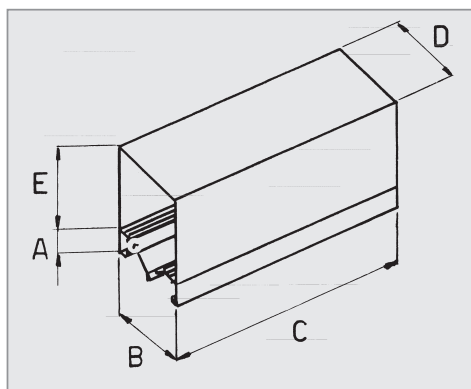
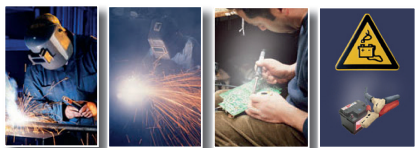

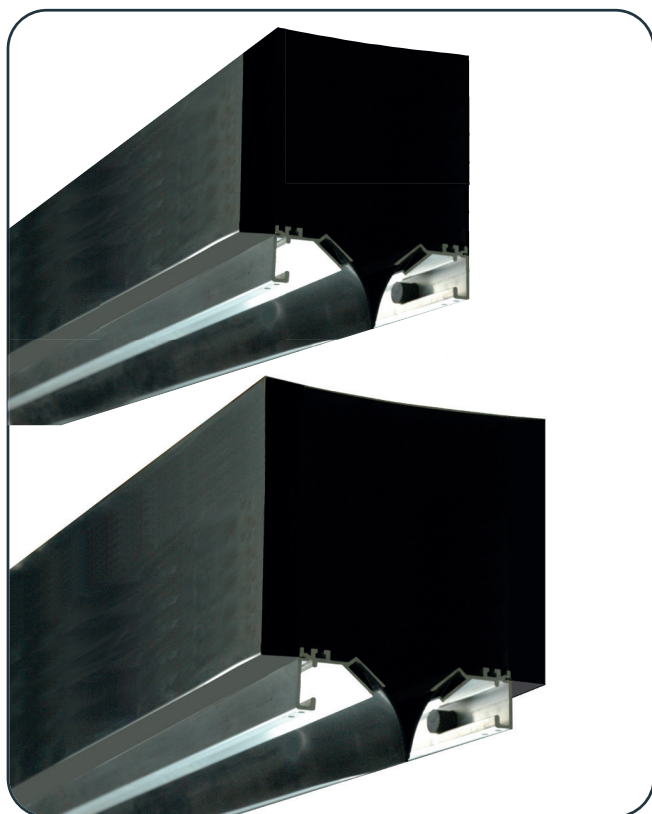

## Dettagli tecnici - Technical details - Données techniques - Technische Daten - Datos Técnicos

MODEL	A (mm)	B (mm)	C (mm)	D (mm)	E (mm)	Ø eq (mm)	m <sup>3</sup> /h MAX	c.f.m. MAX	Kg	Lbs
CZ-3000	53	220	3000	220	135	195	2.350	1382	26,5	58,4
CZ-6000	53	220	6000	220	135	195	2.350	1382	53	116,8
CZ1-2000	53	220	2000	220	200	248	3800	2234	19	41,9
CZ1-6000	53	220	6000	220	200	248	3800	2234	54	119



 Canalina modulare in alluminio per aspirazione di gas e fumi inquinanti tramite elementi scorrevoli porta-tubo o porta-braccio articolato. Caratterizzata da estrema flessibilità di utilizzo, leggerezza e ampia gamma disponibile, la serie CZ è disponibile in varie dimensioni per sopprimere a diversi volumi di aspirazione richiesti.

 Modular aluminium track for extracting pollutant gases and fumes via sliding hose support elements or articulated arm supports. The CZ series is extremely flexible, lightweight and available in a wide range of models and sizes so that it is suitable for various extraction volume requirements.

 Rail modulaire en aluminium pour aspiration de gaz et fumées polluantes par l'intermédiaire d'éléments coulissants porte-tuyau ou porte-bras articulé. Caractérisé par une extrême souplesse d'utilisation, sa légèreté et sa gamme très large, la série CZ existe en plusieurs dimensions pour satisfaire les différents volumes d'aspiration nécessaires.

 Modularer Saugschlitzkanal aus Aluminium für die Abgas- und Rauchabsaugung über mit Laufwagen montierte Schläuche und Gelenkarme. Die Serie CZ zeichnet sich durch außergewöhnliche Flexibilität, Leichtigkeit und ein umfassendes Angebot aus. Sie ist in diversen Abmessungen erhältlich, um den verschiedenen Anforderungen in Hinblick auf das Absaugvolumen nachzukommen.

 Carril modular de aluminio para aspirar gases y humos contaminantes mediante elementos deslizantes porta-tubo o porta-brazo articulado. Caracterizada por la gran flexibilidad de uso, el poco peso y la amplia gama disponible, la serie CZ propone varias dimensiones para dar respuesta a los distintos volúmenes de aspiración requeridos.

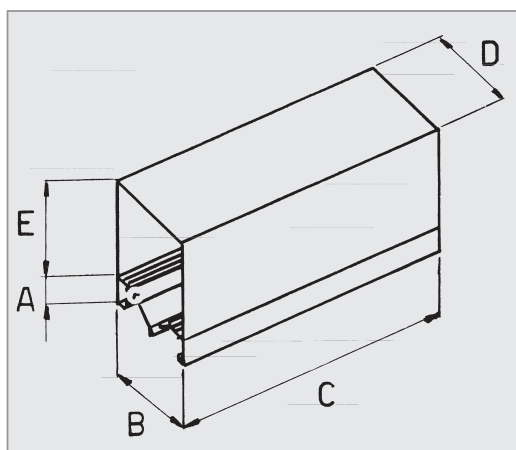
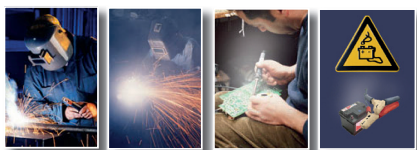

## Dettagli tecnici - Technical details - Données techniques - Technische Daten - Datos Técnicos

MODEL	A (mm)	B (mm)	C (mm)	D (mm)	E (mm)	Ø eq (mm)	m³/h MAX	c.f.m. MAX	Kg	Lbs
CZ2-2000	53	220	2000	220	400	334	6.900	4057	20	44
CZ2-6000	53	220	6000	220	400	334	6.900	4057	58	128
CZ3-2000	53	220	2000	350	500	472	13.850	8144	24	53
CZ3-6000	53	220	6000	350	500	472	13.850	8144	84	185